

Forward Section

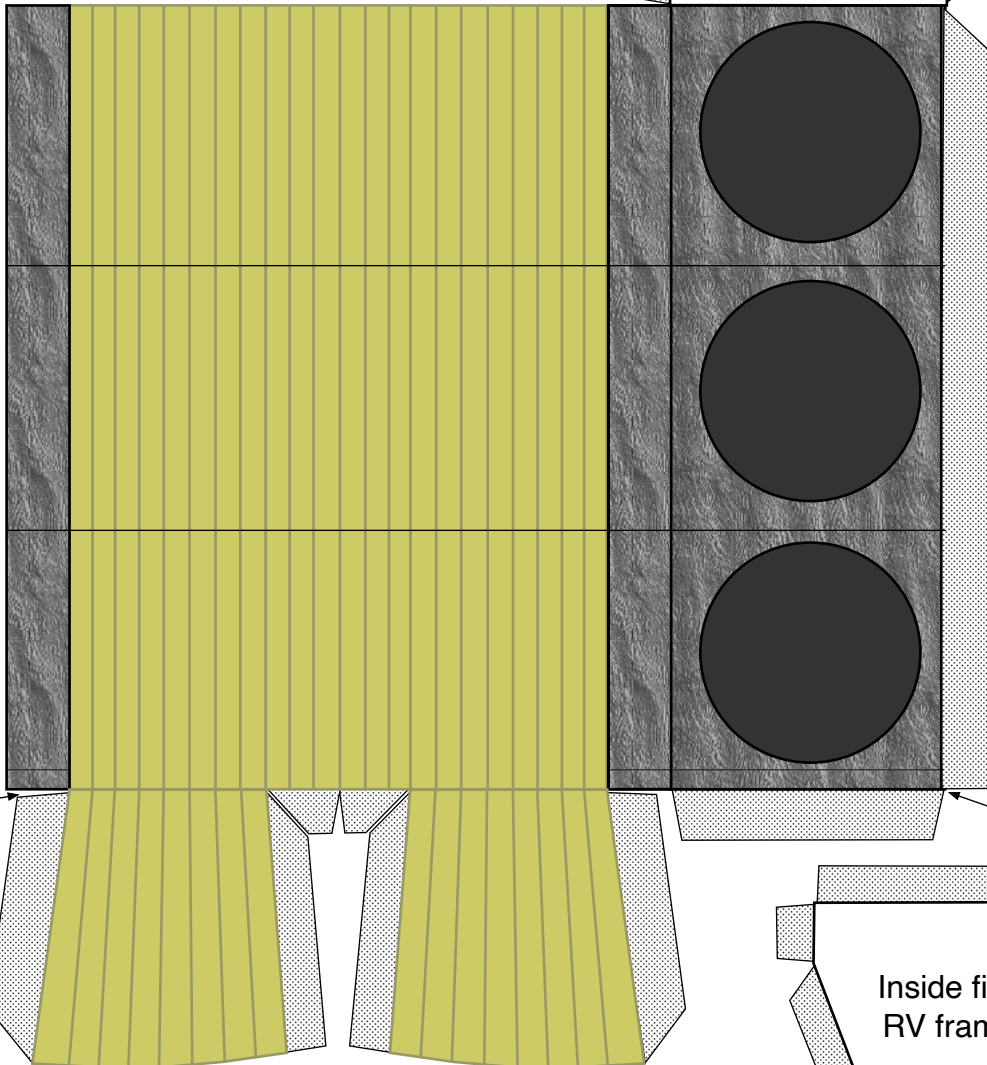

Score on back

Do not score

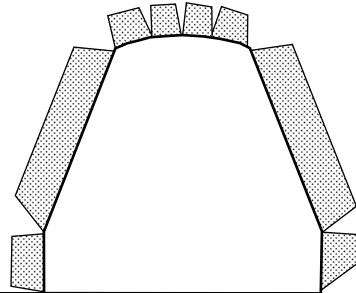
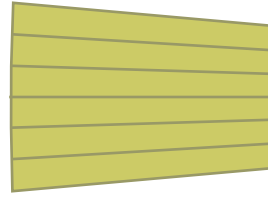
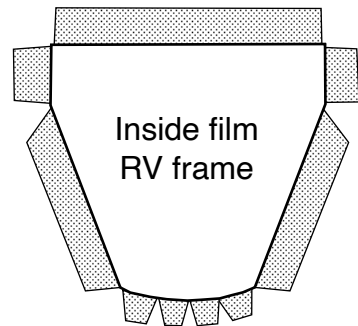

Mid Section

Cut along solid line
(2 places)

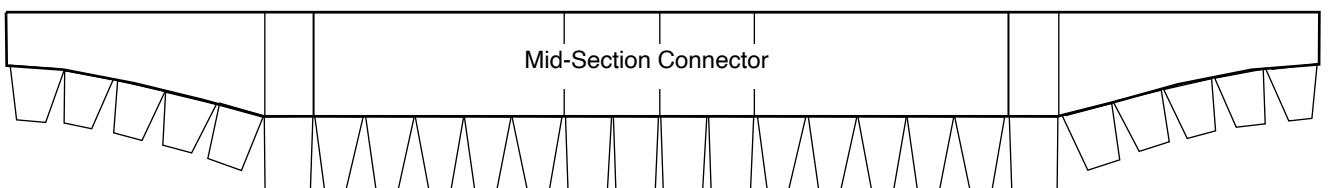
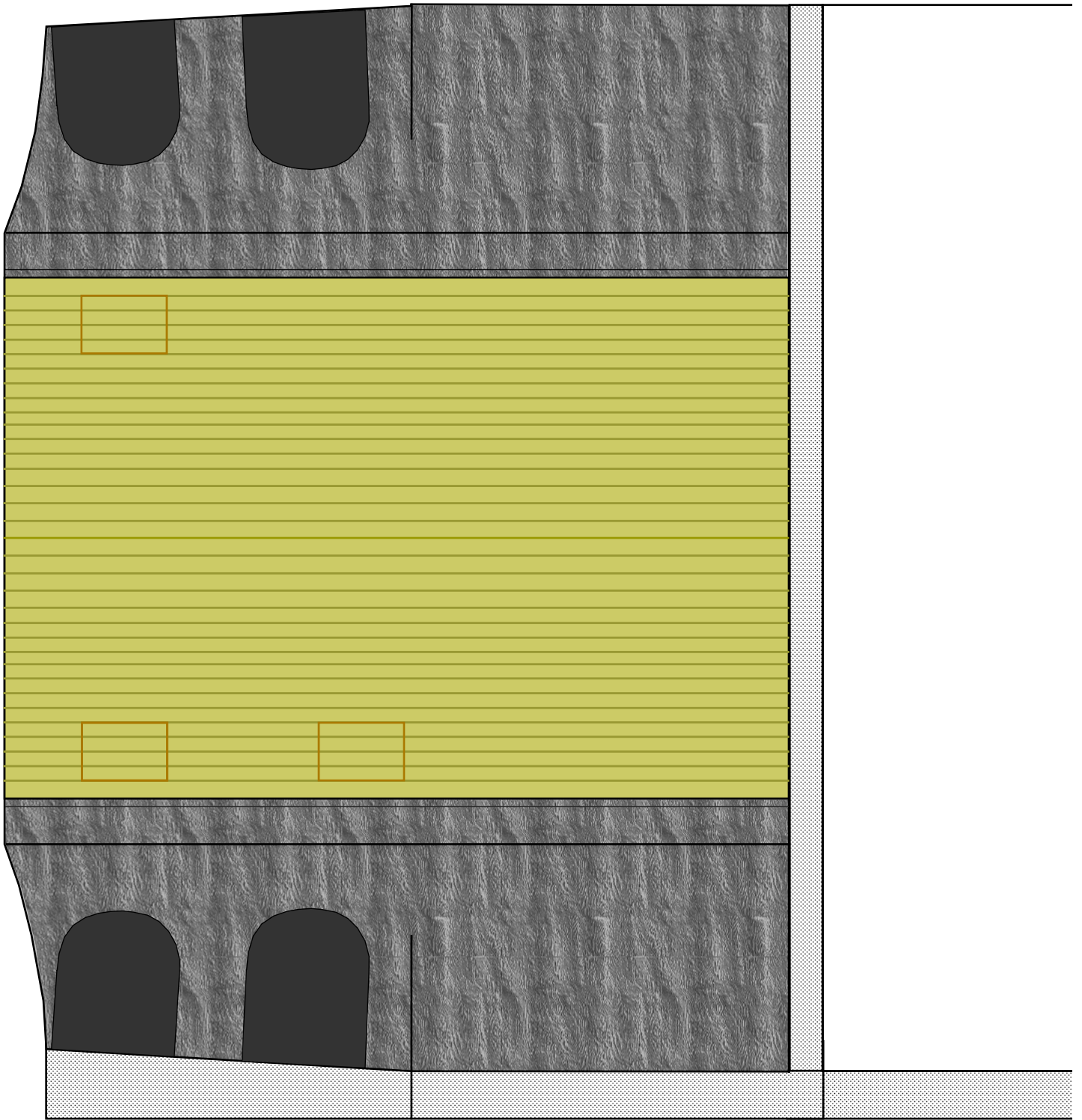

Satellite Control Section

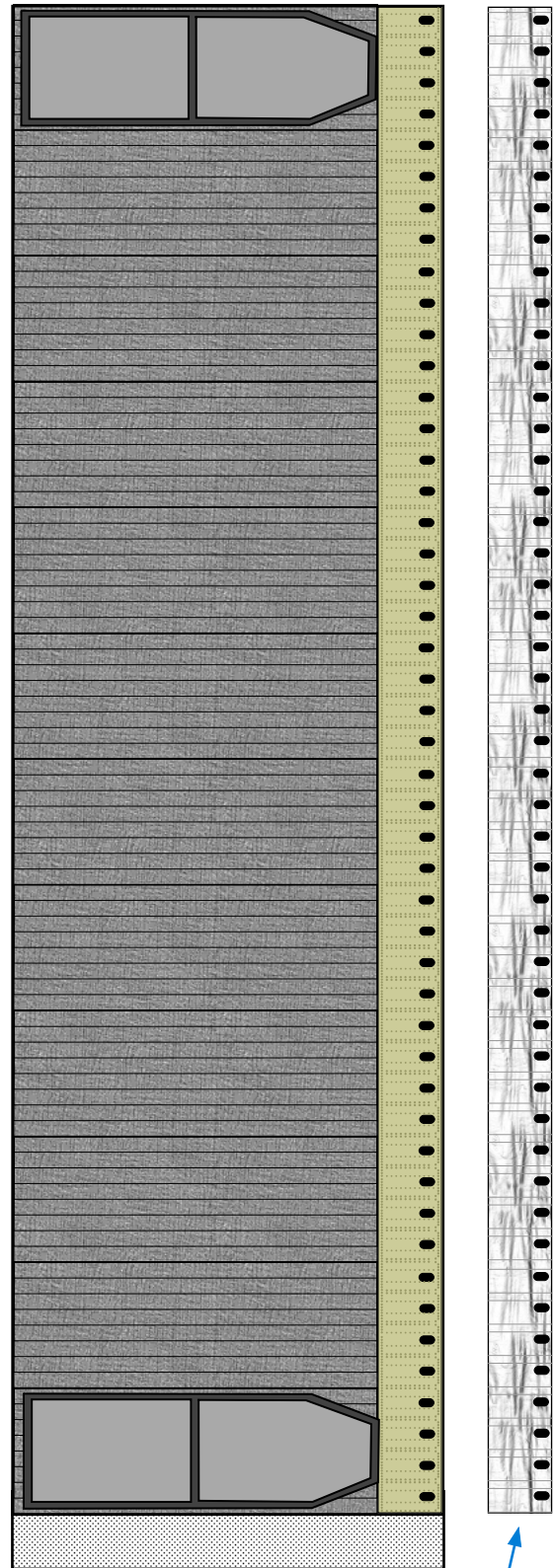
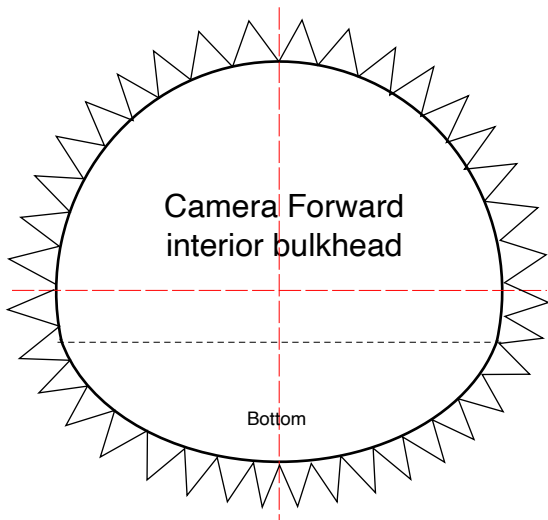
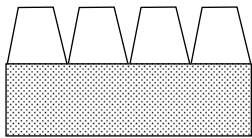
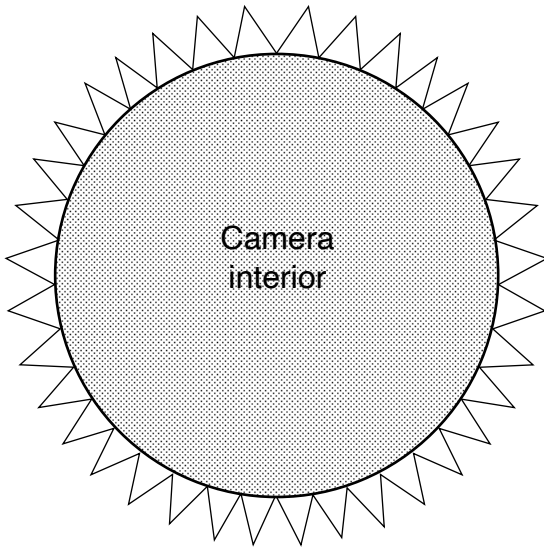
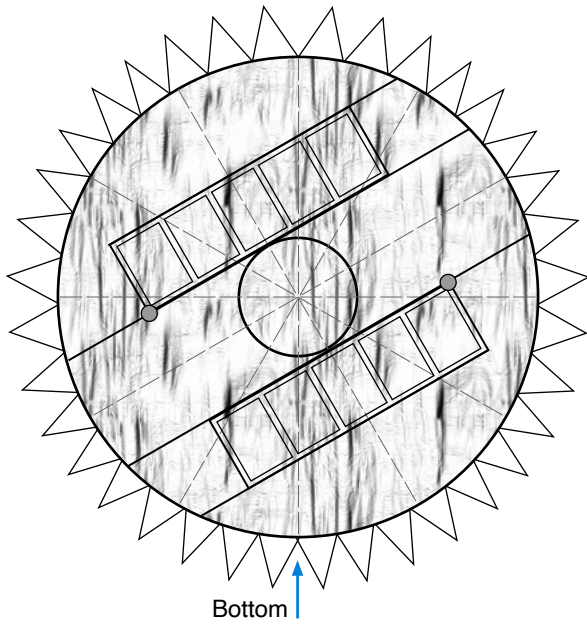

SCS conical adaptor strip

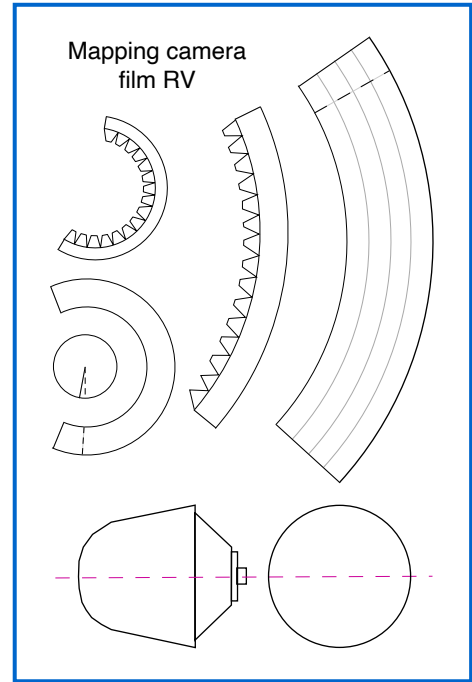
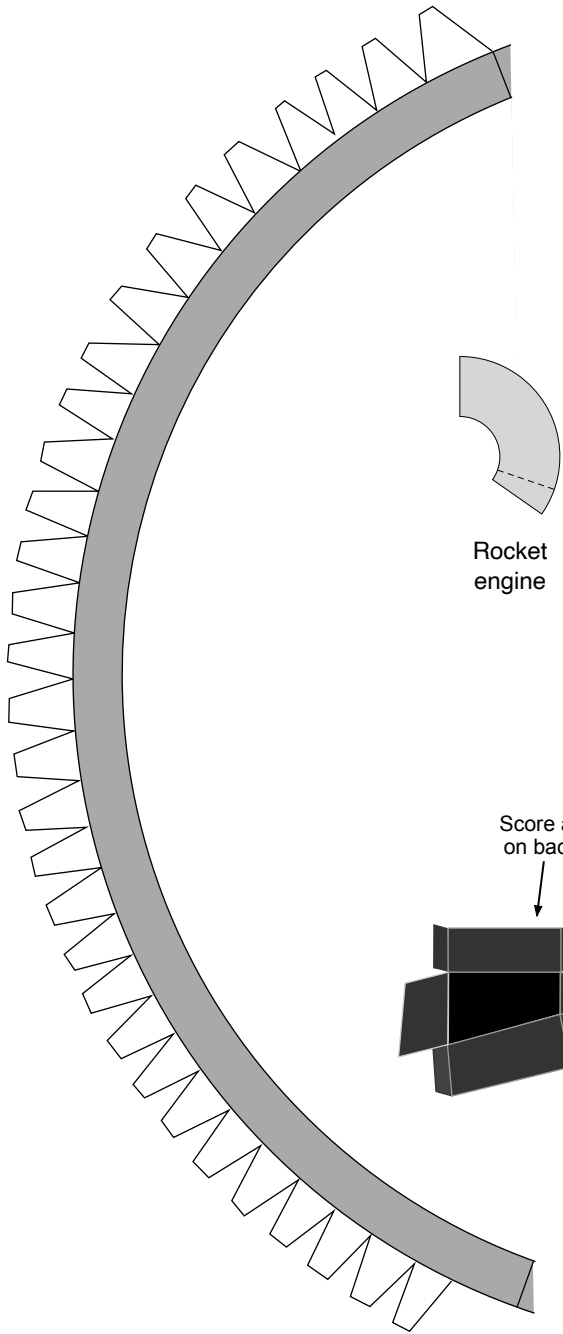

Mapping camera platform

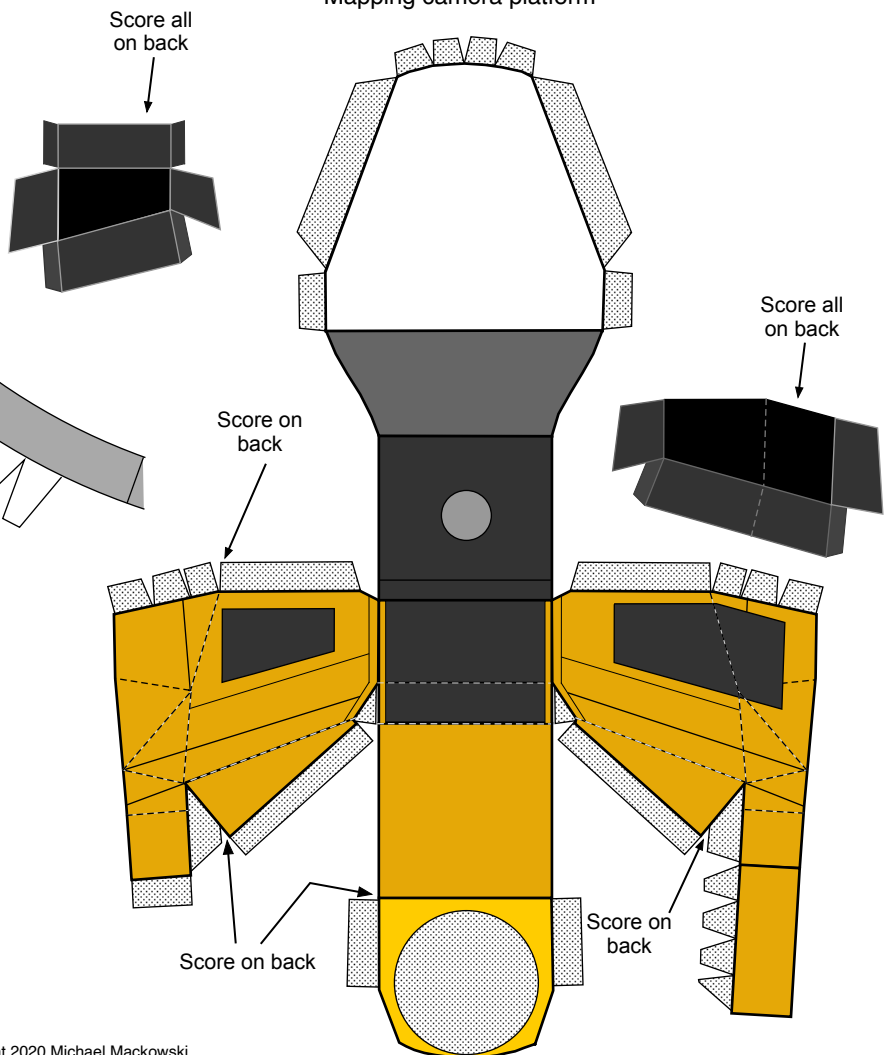

Film buckets (RVs = Reentry Vehicles)

Reference
Side View



Reference
Top View

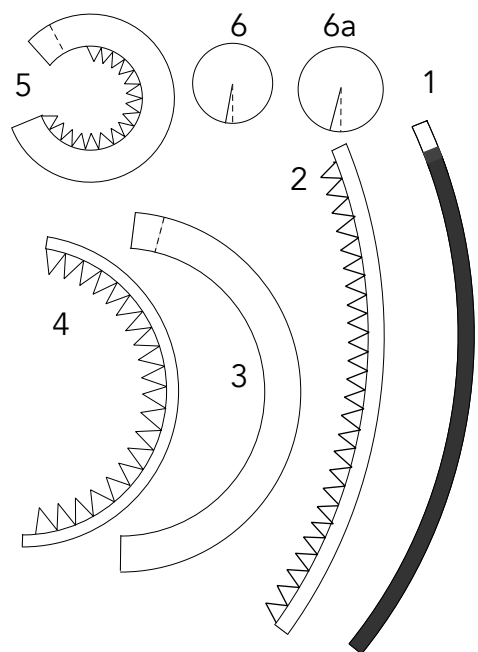
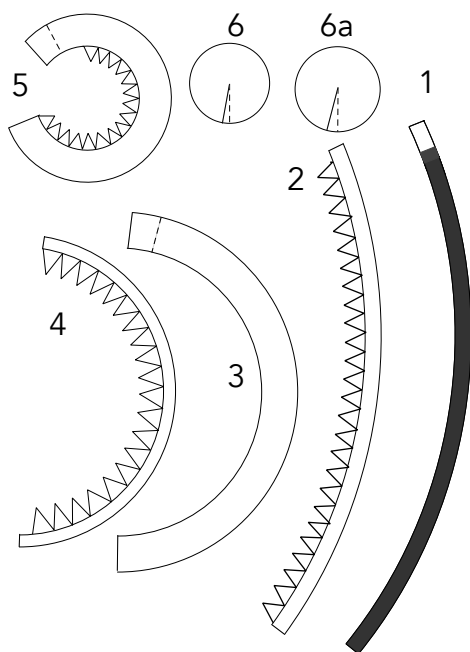
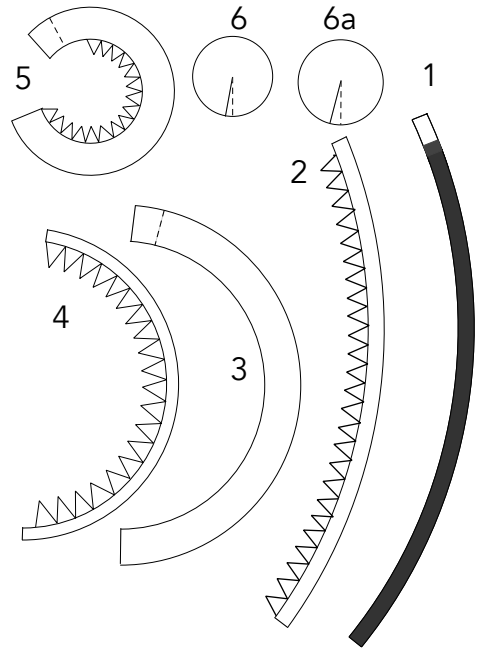
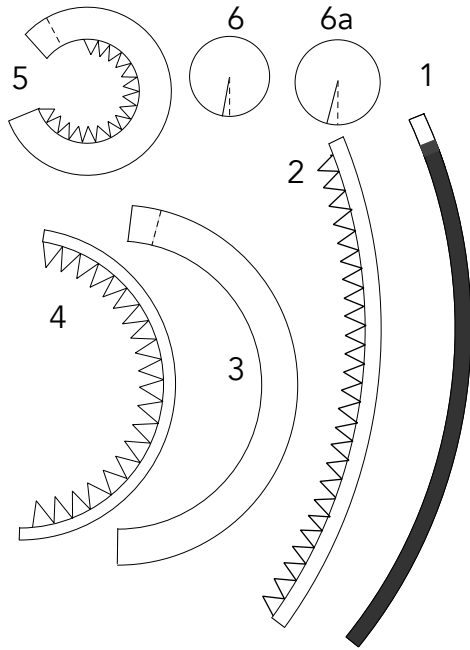
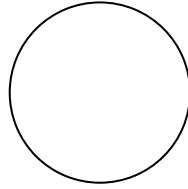

Build-up strip for SCS
Build-up strip for SCS
Build-up strip for SCS
Build-up strip for SCS
Build-up strip for SCS
Build-up strip for SCS
Build-up strip for SCS
Build-up strip for SCS
Build-up strip for SCS
Build-up strip for SCS

Solar panels

